

# CMC™

---

# CLUTCH™

---

by  INDUSTRIAL

Multi-Purpose Device  
Compliant with new European Regulations  
**(EU) 2016/425**

## **WARNING**

Activities involving the use of this device are potentially dangerous. You are responsible for your own actions and decisions. Before using this device, you must:

- Read and understand these user instructions and warnings.
- Get specific training in its proper use.
- Familiarize yourself with its capabilities and limitations.
- Understand & accept the risks involved.

**FAILURE TO HEED ANY OF THESE WARNINGS MAY RESULT IN SEVERE INJURY OR DEATH.**

### Standards



EN 12841: 2006/C  
EN 341: 2011/2A  
EN 15151-1: 2012/8  
ANSI/ASSE Z359.4-2013



Find the Latest Version of the CLUTCH Manual at [cmcpro.com](http://cmcpro.com)



**NFPA 1983 (2017 ED)**

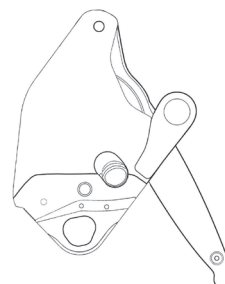

EN  
IT  
FR  
DE  
ES  
PL  
JP  
CN

Patent Pending

## NFPA CERTIFICATION INFORMATION FOR 335011



MEETS THE PULLEY, DESCENT CONTROL AND BELAY DEVICE REQUIREMENTS OF NFPA 1983, STANDARD ON LIFE SAFETY ROPE AND EQUIPMENT FOR EMERGENCY SERVICES, 2017 EDITION.

EMERGENCY SERVICES PULLEY, DESCENT CONTROL AND BELAY DEVICE IN ACCORDANCE WITH NFPA 1983-2017.

- GENERAL USE (G) MBS 40kN (8,992 lbf) PULLEY
- GENERAL USE (G), DESCENT CONTROL, Ø 10.5 - 11 mm
- GENERAL USE (G), BELAY DEVICE, Ø 10.5 - 11 mm

This Descent Control and Belay Device has passed the manner of function and holding load test using the following ropes:

- CMC™ G11™ Lifeline 11 mm P/N 28311X
- Teufelberger KM III 10.5 mm P/N C330X-05-00600

For information on performance with other life safety ropes, please contact CMC or check CLUTCH technical section at [cmcpro.com](http://cmcpro.com)

# Table of Contents

<b>1</b>		Traceability & Markings. . . . .	<b>4</b>
<b>2</b>		Field of Application. . . . .	<b>7</b>
<b>3</b>		Nomenclature. . . . .	<b>9</b>
<b>4</b>		Inspection Points to Verify. . . . .	<b>10</b>
<b>5</b>		Compatibility. . . . .	<b>13</b>
<b>6</b>		Working Principle. . . . .	<b>16</b>
<b>7</b>		Installation/Rigging . . . . .	<b>17</b>
<b>8</b>		Function Test. . . . .	<b>19</b>
<b>9</b>		Securing/Tie Off. . . . .	<b>20</b>
<b>10</b>		Precautions for Use. . . . .	<b>21</b>
<b>11</b>		EN 12841/C. . . . .	<b>23</b>
<b>12</b>		EN 341/2A. . . . .	<b>26</b>
<b>13</b>		ANSI Z359.4 . . . . .	<b>29</b>
<b>14</b>		Heavy Loads/Expert Use Only. . . . .	<b>30</b>
<b>15</b>		NFPA 1983 (2017 ED). . . . .	<b>31</b>
<b>16</b>		Rescue System Belaying. . . . .	<b>32</b>
<b>17</b>		Hauling. . . . .	<b>33</b>
<b>18</b>		EN 15151-1 Type 8 . . . . .	<b>34</b>
<b>19</b>		Ascending. . . . .	<b>36</b>
<b>20</b>		Additional Information. . . . .	<b>37</b>
<b>21</b>		Equipment Record. . . . .	<b>38</b>
<b>22</b>		Device Periodic Check Sheet . . . . .	<b>39</b>

1 | Traceability & Markings

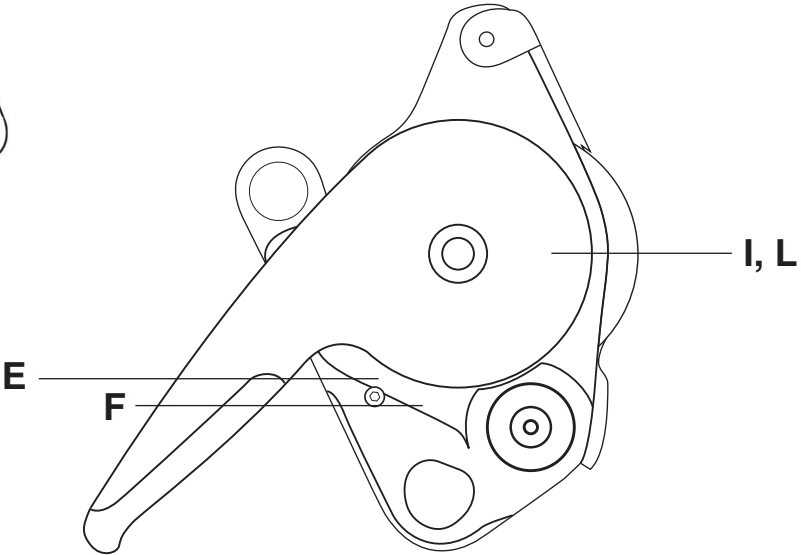
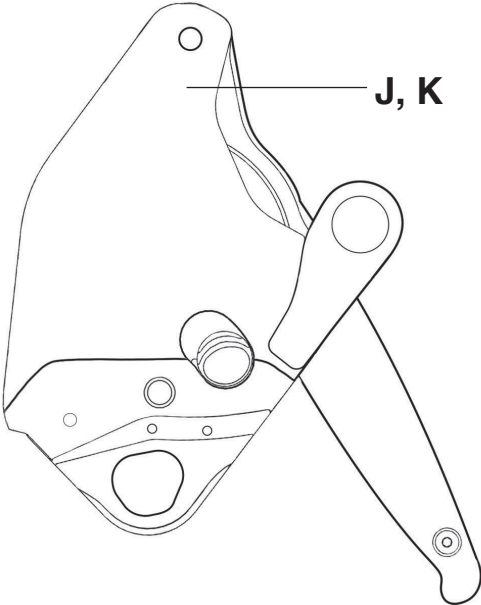
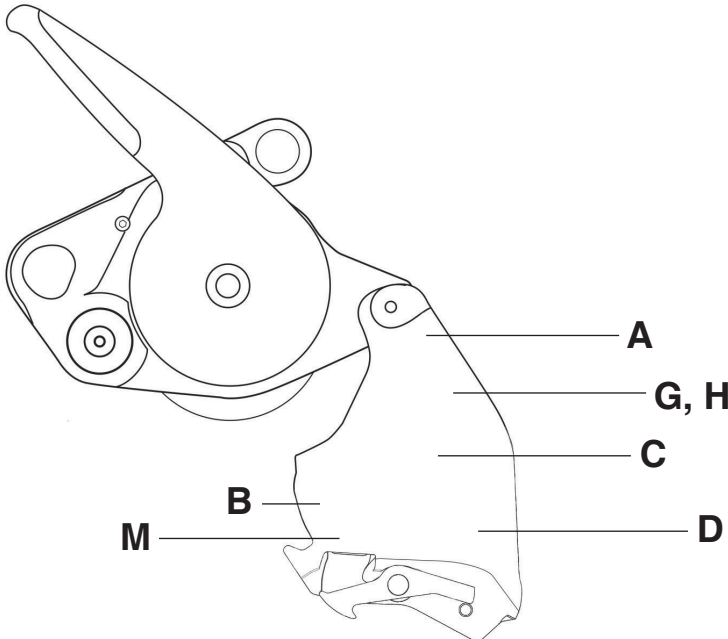

# 1 | Traceability & Markings

## A. CE Mark and Number of the Body Controlling Production of this Personal Protective Equipment



DOLOMITICERT SCARL (N.B. 2008)  
7/A Via Villanova, Longarone, BL 32013, Italy  
Tel. +39.0437.573407 Fax +39.0437.573131

## B. Mark and Information of NFPA Certification Body



## C. Standard Markings

MEETS NFPA 1983 (2017 ED)  
Descent Control "G" Ø 10.5 – 11mm  
Belay "G" Ø 10.5 – 11 mm  
Pulley, "G" MBS 40 kN, Becket 22 kN

EN 341:2011/2A  
Teufelberger PATRON  
⊙ Ø 10.5 mm MAX 200 m, 30-230 kg  
⊙ Ø 11 mm MAX 200 m, 30-240 kg  
T > -30°C

EN 15151-1:2012/8  
Ø 10.5 – 11 mm

ANSI Z359.4-2013 - Rescue  
⊙ 60-141kg Ø 11 mm ONLY ⚠  
MAX 200m Multiple Use n=2  
Avoid chemical, thermal or  
electrical hazards



EN 12841:2006/C  
200kg ⊙ Ø 10.5 - 11 mm, 2.0 m/s MAX  
240kg ⊙ Ø 10.5 - 11 mm, 0.5 m/s MAX

## D. Carefully Read the Instructions for Use



## E. Model Identification 335011

## F. Individual Number

0000 000 - 000

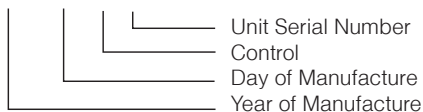

# 1 | Traceability & Markings

**G. Inspection Interval (Minimum 12 months)**



**H. Special Notice or Caution**



**I. Anti-panic Stop**



**J. Anchor/Load End of Rope**



**K. Free End of Rope**



**L. Handle Positions**

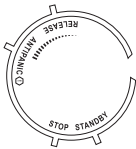

**M. Manufacturer & Contact Information**

CMC Rescue, Inc.  
6740 Cortona Drive  
Goleta, CA 93117 USA

## 2 | Field of Application

These instructions explain the correct use of your equipment. Only certain techniques and uses are described. The warning symbols inform you of some potential dangers related to the use of your equipment, but it is impossible to describe them all. Check [cmcpro.com](http://cmcpro.com) for updates and additional information. You are responsible for heeding each warning and using your equipment correctly. Any misuse of this equipment will create additional dangers. Contact CMC if you have any doubts or difficulty understanding these instructions.

### **Field of Application**

Multi-purpose device. This is not a single-use device.

This equipment is personal protective equipment (PPE) used for fall protection during work and rescue. This product meets the requirements of Regulation (EU) 2016/425 on personal protective equipment only when used as a type C rope adjustment device (EN12841) and as a braking device with manually assisted locking (EN 15151-1). When used as a working line descender in rope access systems (EN 12841/C), the device prevents against limited falls from a height. When used as a braking device with manually assisted locking in mountaineering, climbing and related activities (EN 15151-1 Type 8), the device protects the user from falls from a height for example when belaying. The EU declaration of conformity is available at [cmcpro.com](http://cmcpro.com).

### **Standards & Certifications**

Rope Adjustment Device per EN 12841:2006 Type C

Rescue Descender per EN 341:2011 Type 2A

Belay and Rappel Device per EN 15151-1:2012 Type 8

Rescue Descender per ANSI Z359.4-2013

Pulley, Descender, Belay Device per NFPA 1983 (2017 ED)

## 2 | Field of Application

### Responsibility

**WARNING: Activities involving the use of this device are inherently dangerous. You are responsible for your own actions, decisions and safety.**

Before using this device, you must:

- Read and understand these user instructions and warnings.
- Get specific training in its proper use.
- Familiarize yourself with its capabilities and limitations.
- Understand and accept the risks involved.
- Have a rescue plan in place to deal with any emergencies that could arise during use of the device.
- Be medically fit for activities at height. Be capable to control their own security and any possible emergency situations.

**WARNING: Inert suspension in a harness can result in serious injury or death.**

Specific training in the activities defined in the field of application is essential before use. This device must only be used by competent and responsible persons, or those placed under the direct and visual control of a competent and responsible person. Gaining an adequate expertise in appropriate techniques and methods of protection is your own responsibility. You personally assume all risks and responsibilities for all damage, injury or death, which may occur during or following incorrect use of this device in any manner whatsoever. If you are not able, or not in a position to assume this responsibility or to take this risk, do not use this equipment.

This device must not be loaded beyond its strength rating, nor be used for any purpose other than that for which it is designed.

This equipment does not need to be a personal issue item.



### 3 | Nomenclature

#### Nomenclature of Parts

- (1) Moving Side Plate
- (2) Side Plate Release Latch
- (3) Tension Rope Guide
- (4) Sheave
- (5) Sheave Swing Arm
- (6) Friction Shoe
- (7) Becket
- (8) Control Handle
- (9) Chassis
- (10) Attachment Eye
- (11) Side Plate Lockout Screw Hole
- (12) Side Plate Lockout Screw
- (13) Handle Positions
  - A. Stop
  - B. Stand By
  - C. Release (Range)
  - D. Anti-panic
- (14) Rope Path
  - A. Tension Side (Load/Anchor)
  - B. Braking Side
  - C. Brake Hand

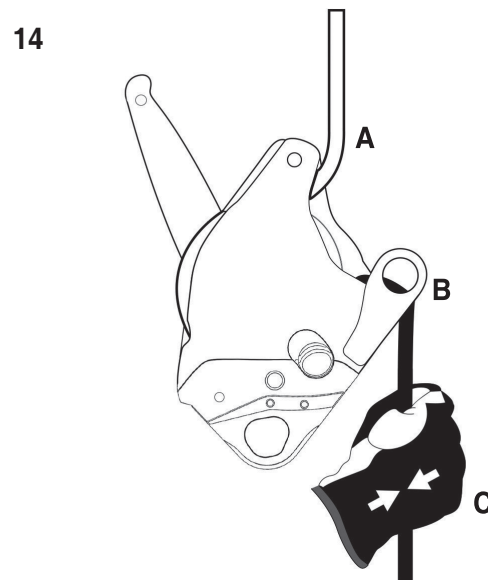
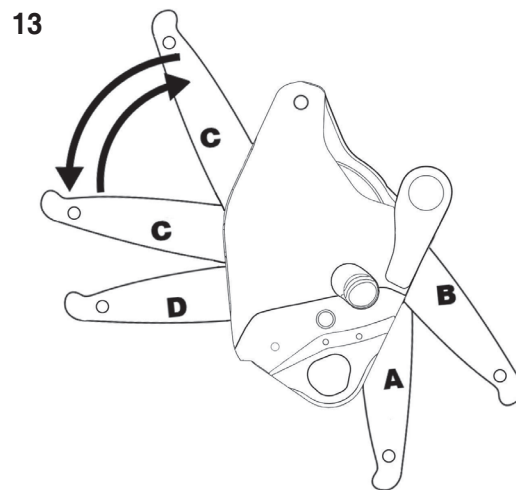
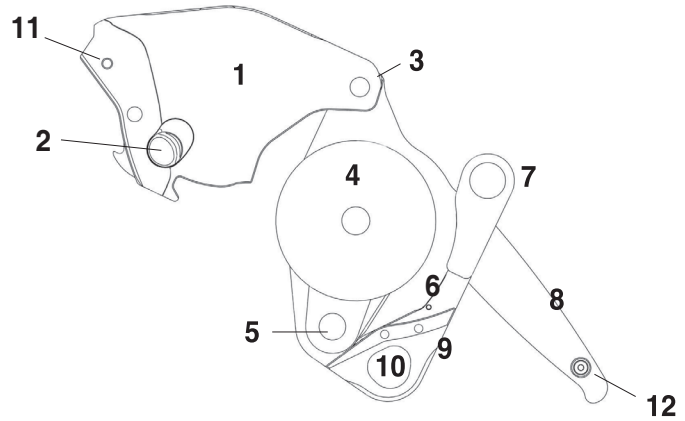

## 4 | Inspection Points to Verify

### Inspection Points to Verify

The CLUTCH is controlled through CMC's ISO 9001 approved quality processes, however it should be thoroughly inspected before being placed in service. The CLUTCH is also a robust product but should still be inspected after each use to ensure that damage did not occur. The CLUTCH does not have a known time-limit to the usable life, however CMC recommends a detailed inspection by a competent person at least once every 12 months (depending on current regulations in your country, and your conditions of use). Record the date of the inspection and the results in the equipment log or on inspection forms that can be found on [cmcpro.com/ppe-inspection/](http://cmcpro.com/ppe-inspection/).

### Before Each Use

- Verify the presence and legibility of the product markings.
- Verify that the device has no cracks, deformation, excessive wear, corrosion, etc.
- Check for the presence of dirt or foreign objects that can affect or prevent normal operation (e.g. grit, sand, pebbles, etc.).
- Move the Control Handle through its range of motion.
- Move the Control Handle to the Stand By position and check that the Sheave Swing Arm moves freely.
- Check that the Sheave is in good condition and freely rotates only anti-clockwise.
- Check the Sheave for wear; when the Sheave becomes worn all the way to the wear indicator (see diagram), discontinue use of the CLUTCH.
- Check the Side Plate for deformation or excessive play; if the Side Plate can pass over the Chassis (see diagram), discontinue use of the CLUTCH.

### During Each Use

Make sure that all pieces of equipment in the system are correctly positioned with respect to each other. Regularly monitor the condition of the device and its connections to other equipment in the system. Do not allow anything to interfere with the operation of the device or its components (Sheave, Control Handle, etc.). Keep foreign objects out of the device. To reduce the risk of a free fall keep all slack out of the rope between the device and the load/anchor. **Warning:** performance can vary depending on the state of the rope (wear, mud, moisture, ice, etc).

# 4 | Inspection Points to Verify

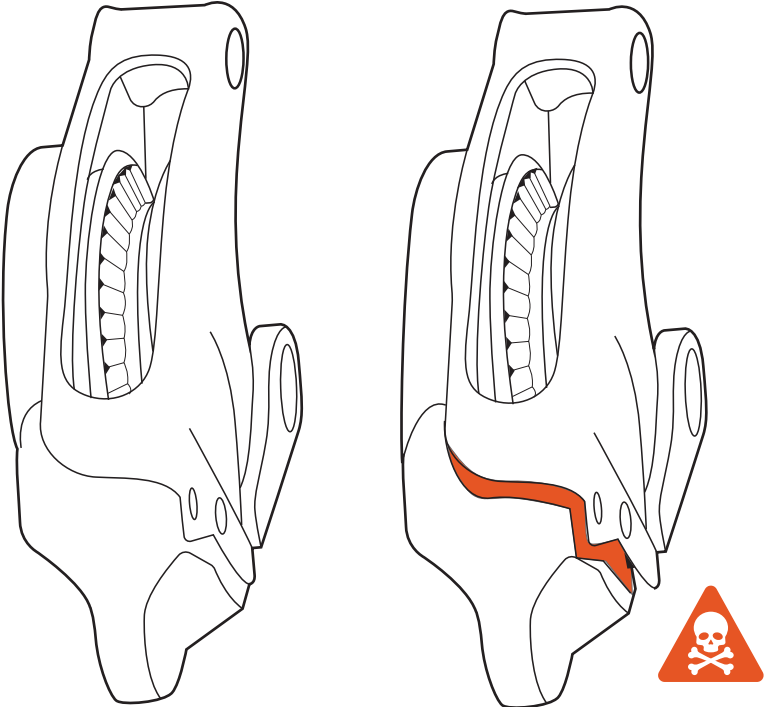
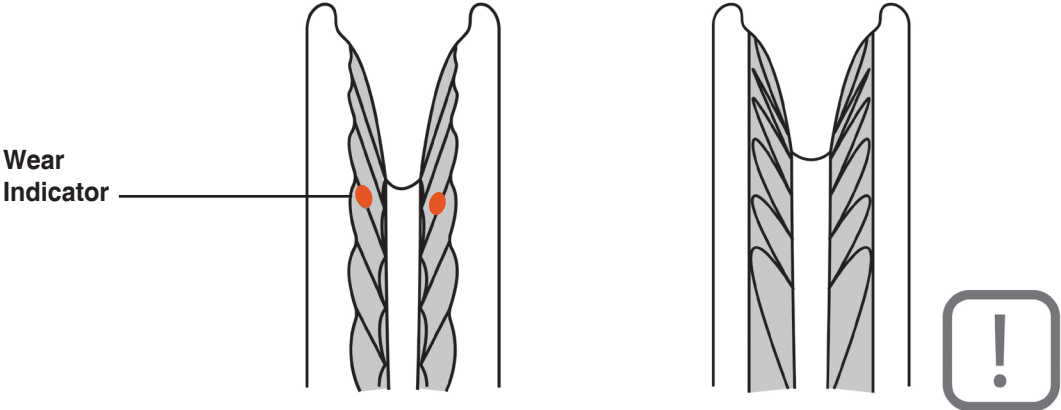
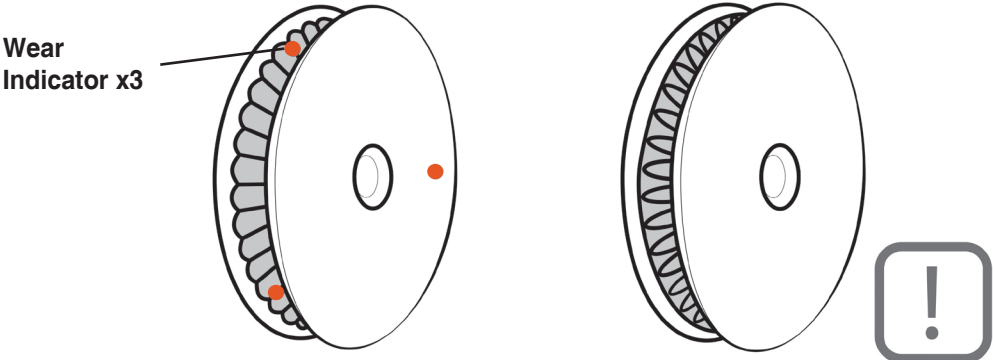

## 4 | Inspection Points to Verify

**This equipment has an unlimited lifetime, however usage and exceptional events may require retirement.**

**WARNING:** An exceptional event can lead you to retire a device after only one use, depending on the type and intensity of usage and the environment of usage (harsh environments, marine environment, sharp edges, extreme temperatures, chemical products, etc.)

A device must be retired when:

- It has been subjected to a major fall (or load).
- It fails to pass inspection.
- You have any doubt as to its condition or reliability.
- You do not know its full usage history.
- When it becomes obsolete due to changes in legislation, standards, technique or incompatibility with other equipment, etc.

Destroy retired equipment to prevent further use.

### **CARRYING, MAINTENANCE, STORAGE & TRANSPORT**

Clean and dry this equipment after each use to remove any dust, debris and moisture. Use clean water to wash off any dirt or debris. Do not use a pressure washer to clean the device. If device gets wet, allow the device to air dry at temperatures between 10° C and 30° C, keep away from direct heat. During use, carrying, storage and transport, keep the equipment away from acids, alkalis, rust and strong chemicals. Do not expose the equipment to flame or high temperatures. Store in a cool, dry location. Do not store where the equipment may be exposed to moist air, particularly where dissimilar metals are stored together. Ensure that the equipment is protected from external impact and keep out of direct sunlight.

### **REPAIR**

All repair work shall be performed by the manufacturer. All other work or modifications void the warranty and releases CMC from all liability and responsibility as the manufacturer.

Note: It is essential for the safety of the user that if the product is re-sold outside the original country of destination, the reseller shall provide instructions for use, for maintenance, for periodic examination and for repair in the language of the country in which the product is to be used.

## 5 | Compatibility

### Compatibility

Verify that this device is compatible with the other elements of the system in your application (compatible = good functional interaction).

**WARNING:** Danger may arise and functionality may be compromised by combining other items of equipment in conjunction with the CLUTCH during use. The user assumes all responsibility for any non-standard use of the device or the components being used with the device.

#### EN 12841/C Descender

● = EN 1891 Type A

10.5 ≤ Ø ≤ 11 mm MAX 200kg, 2.0 m/s MAX

10.5 ≤ Ø ≤ 11 mm MAX 240kg, 0.5 m/s MAX



#### EN 341/2A Rescue and Evacuation Device

● = EN 1891 Type A

Teufelberger Patron Ø 10.5mm 30-230kg, MAX 200m

Teufelberger Patron Ø 11mm 30-240kg, MAX 200m

#### EN 15151-1/8 Belay Device

① = EN 892 Single, 10.5 ≤ Ø ≤ 11 mm

● = EN 1891/A, 10.5 ≤ Ø ≤ 11 mm for abseiling only

#### ANSI-ASSE Z359.4 Rescue and Evacuation Descent Device

CMC G11 Lifeline Ø 11mm 60-141kg MAX 200m

#### NFPA 1983 “GENERAL USE” Descent Control Device / Belay Device / Pulley

Teufelberger KMIII Ø 10.5 mm Technical Use Life Safety Rope

CMC G11 Lifeline Ø 11mm General Use Life Safety Rope

## 5 | Compatibility

### Rope

Use only the recommended diameters and types of synthetic rope. The use of any other diameter/type of rope changes the performance of the device, especially the braking effectiveness.

**WARNING:** The stated diameter of ropes on the market may have a tolerance of up to +/- 0.2 mm. Certain ropes may be slippery: new ropes, small diameter ropes, wet or frozen ropes. Braking effectiveness and ease of giving slack can vary depending on the diameter, construction, wear and tear, and surface treatment of the rope, as well as other variables such as frozen, muddy, wet, dirty ropes, etc. At each use, the user must familiarize him or herself with the braking effect of the device on the rope and ensure that the rope is in good condition. Ensure that the braking side of the rope has a stop knot or other termination. The device may heat up during descent and damage the rope: take care. Safe operation of the device is dependent on the condition of the rope—if the rope is damaged, it must be replaced.

### Harness

- EN 12841/C use: Sit harness or EN 813 (ventral attachment point).
- EN 341/2A use: EN 361 full body harness (sternal or ventral points).
- EN 813, or rescue harness certified to EN 1497.
- EN 15151-1/8 use: EN 12277 and/or EN 813 (ventral attachment point).
- ANSI Z359.4 use: ANSI Z359.11 full body harness (sternal or ventral points).

**Note:** A full body harness is the only acceptable body holding device that can be used in a fall arrest system.

### Carabiner

Use only carabiners with locking gates.

- EN 12841/C use: EN 362 Class B carabiners.
- EN 341/2A use: EN 362 Class B carabiners.
- EN 15151-1/8 use: EN 12275 carabiners.
- ANSI Z359.4 use: ANSI Z359.12 carabiners.
- NFPA 1983 (2017 ED) use: Technical or General Use carabiners.

## 5 | Compatibility

### **Anchors**

Anchors must comply with EN795, ANSI Z359.4, ANSI Z359.18, or have a resistance greater than 15kN. For mountaineering use (EN 15151-1), use anchors that are in compliance with EN 959 (rock anchors), EN 568 (ice anchors), EN 569 (pitons), EN 12270 (chocks), or EN 12276 (frictional anchors). It is essential that the device and the anchor points are always correctly placed, and that the work is organized in such a way to minimize the risk of a fall from a height. Always ensure enough clearance to avoid impacts with the ground or other obstacles in case of a fall. Contact CMC if you are uncertain about the compatibility of your equipment.

## 6 | Working Principle

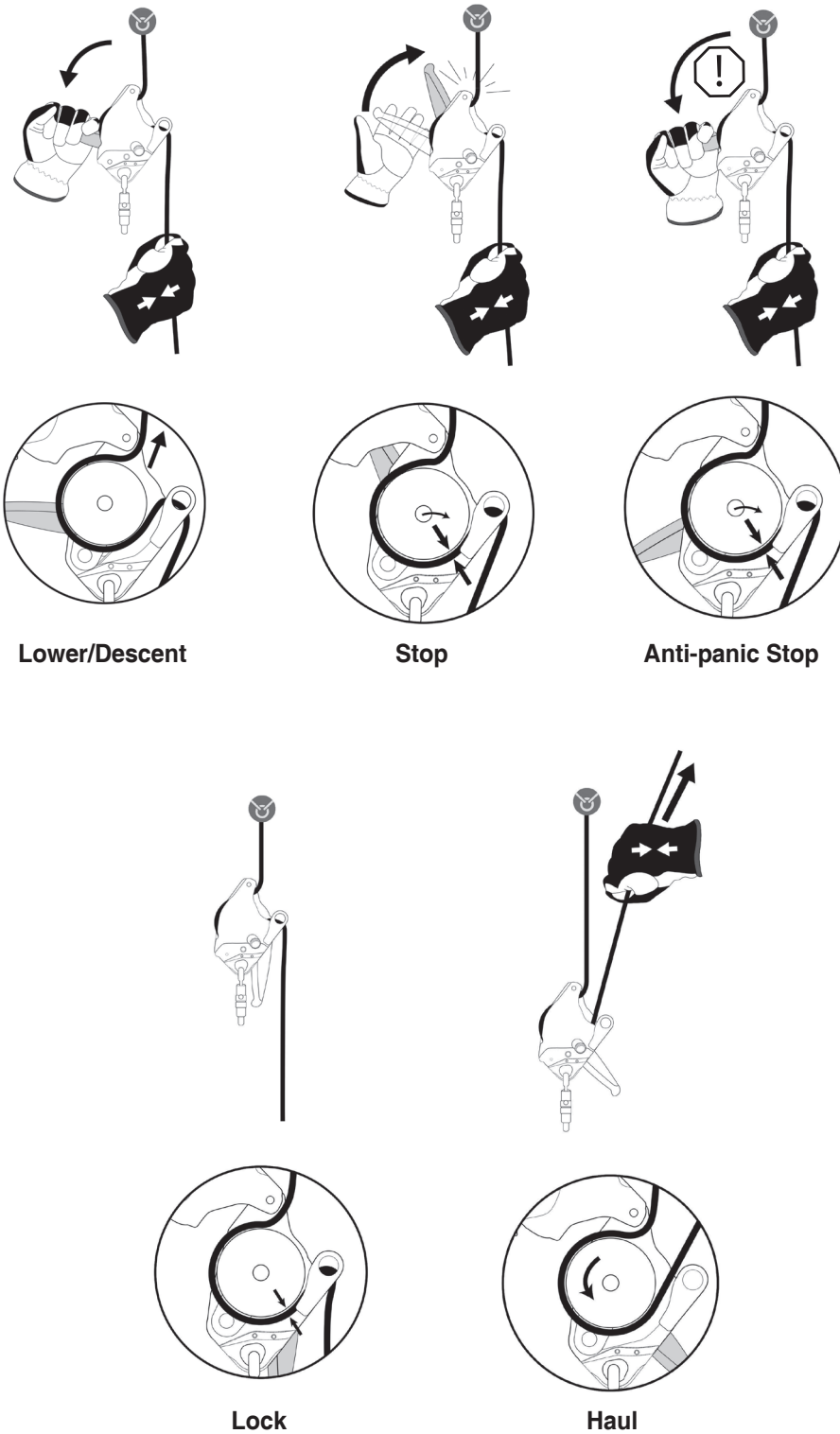

The CLUTCH allows the rope to be pulled through in one direction, but friction of the rope on the Sheave in the other direction causes the Sheave to lock, pivot and capture the rope between the Sheave and Friction Shoe. By holding the braking side of the rope, the Brake Hand helps engage the braking mechanism.



## 7 | Installation / Rigging

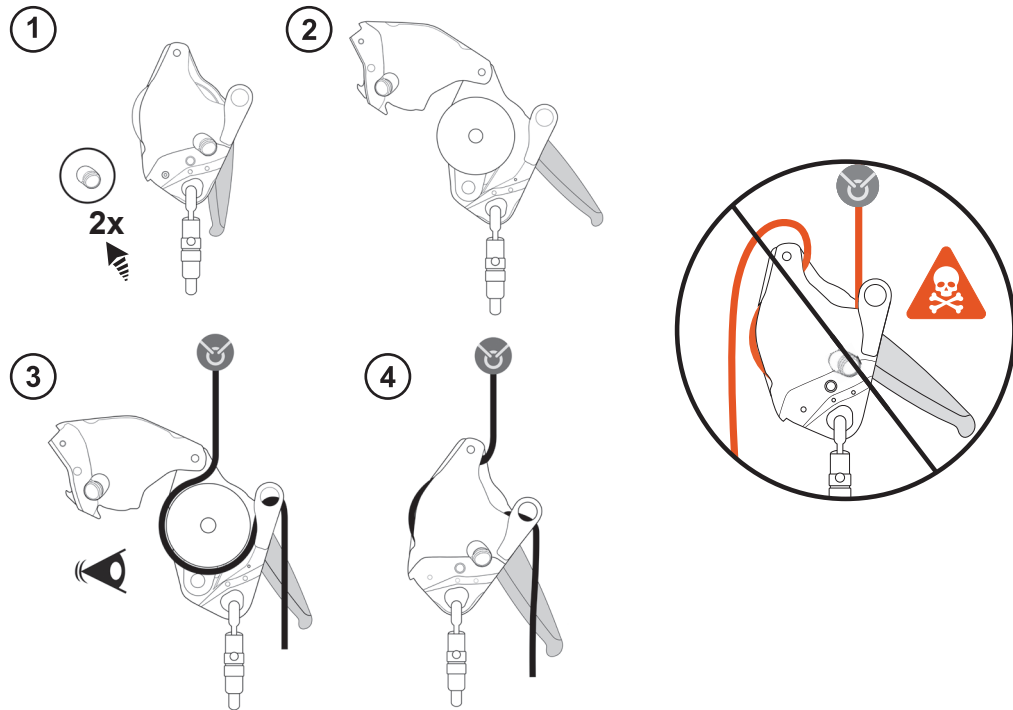

### Installing the Rope

- (1) Open the Side Plate by activating the Side Plate Release Latch 2 times.
- (2) Move the Control Handle to the Stand By position.
- (3) Load the rope according to the diagram marked on the device.
- (4) Close the Side Plate and secure the device to an appropriate attachment point or anchor with a locking connector.

 Loading the rope incorrectly could cause imminent risk of injury or death.

### Usage on Anchor

In tight clearance or overhead rigging solutions an extra carabiner is recommended to improve ergonomics, redirect the rope and/or improve alignment of rope into the device. An extra carabiner may also be used to increase friction on the free end of the rope for heavy load applications.

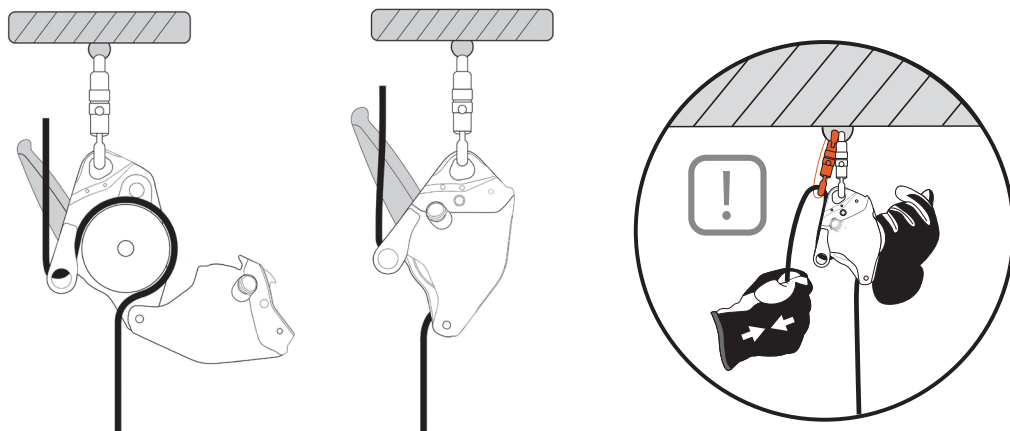

## 7 | Installation / Rigging

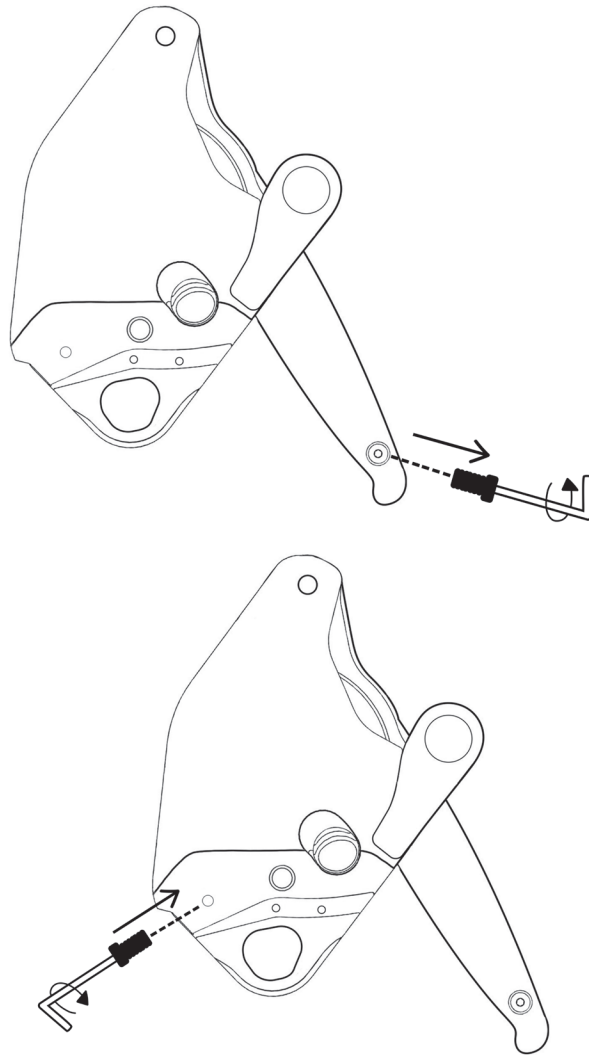

### **Locking the Side Plate and Latch**

If necessary, it is possible to lock the Side Plate and Latch mechanism, after the rope is installed (i.e. when used as a rescue kit). Install the Side Plate Lock Out Screw (stored on the handle) into the Side Plate Lockout Screw Hole in the Side Plate. Check that Side Plate and Latch are secure.

## 8 | Function Test

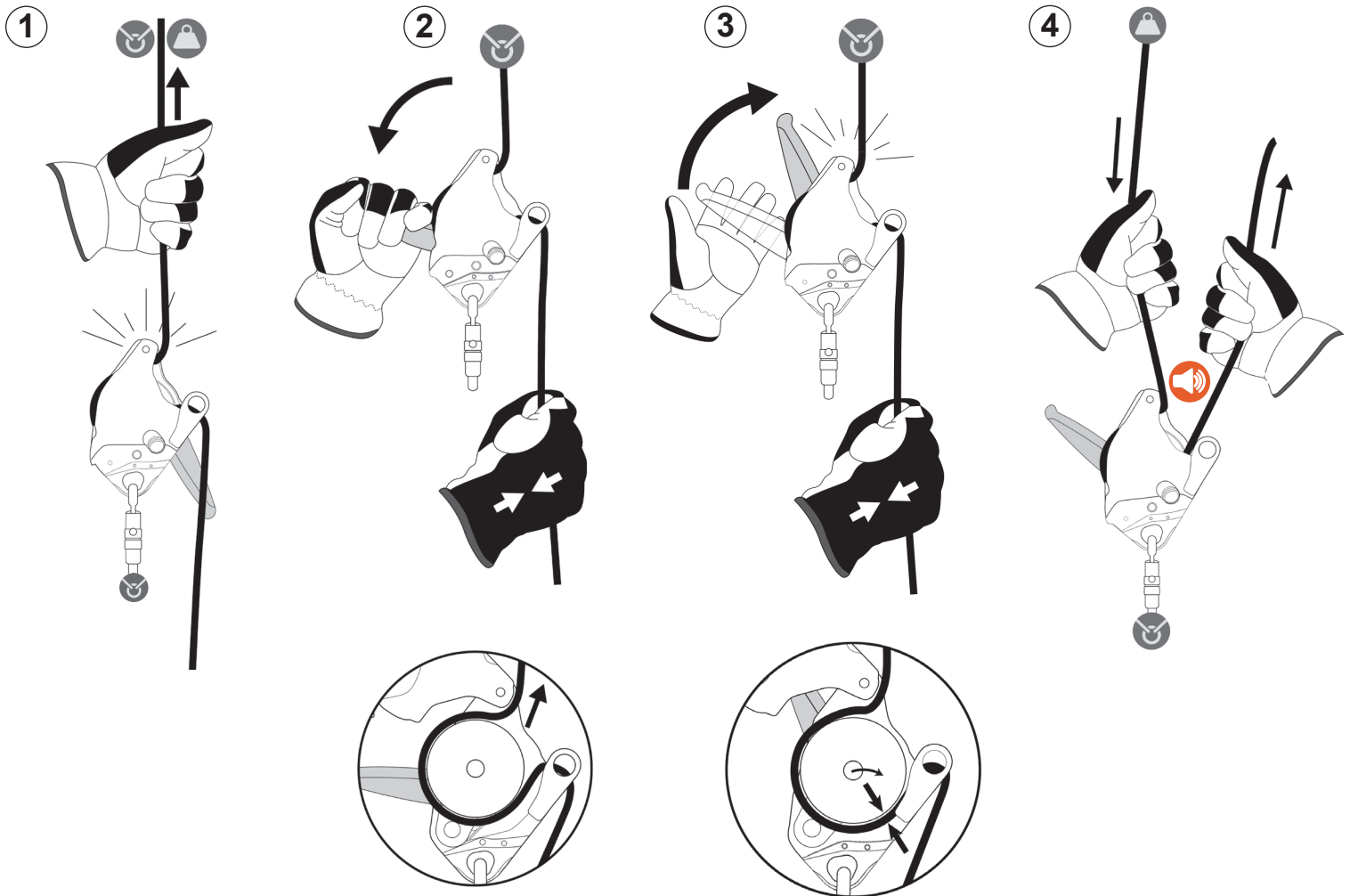

### Function Test

Before each use, verify that the rope is correctly installed and that the device is working properly. The CLUTCH must be properly rigged prior to use. Always use a backup safety system when performing this test.

- 1) Move the Control Handle to the Stand By Position and give a quick pull on the anchor/load side of the rope. When rigged correctly the CLUTCH will lock up.
- 2) Gradually apply a load to the device (rope taut, handle in stand by position). While firmly gripping the braking side of the rope, gradually move the Control Handle to Descent Position to allow rope through the device.
  - Descent is possible = rope correctly installed.
  - Descent is not possible = check the installation of the rope.
- 3) When the Control Handle is released, the CLUTCH should lock up and hold the rope.
- 4) Pull rope through the device as if using it to haul. Audible clicking sound should be noticeable.

 **WARNING: DANGER OF DEATH.** Do not allow anything to interfere with the operation of the device or its components (Sheave, Control Handle, etc.). Any constraint on the device may negate the braking function.

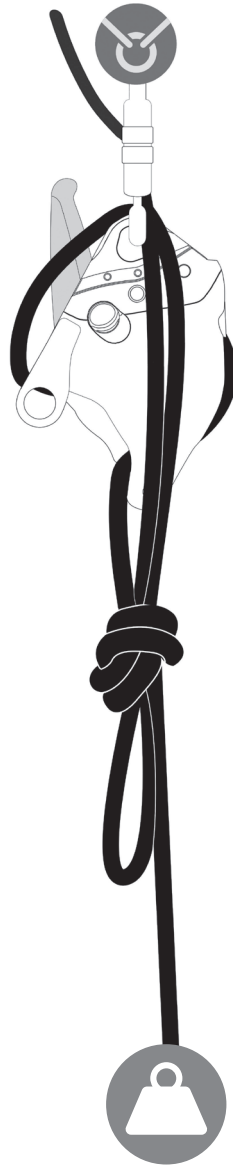

### Securing

**NOTE:** In the case where a secure tie-off is necessary, it is recommended to secure the system by tying off the free end of the rope around the load/tension side of the rope with an appropriate tie-off method (see diagram).

When securing as recommended in the diagram (or with any other tie-off method) a minimum of 6" [152 mm] should be maintained between the knot and the device.

10 | Precautions for Use

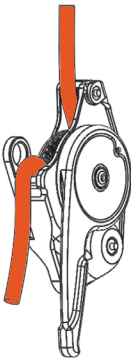

OK

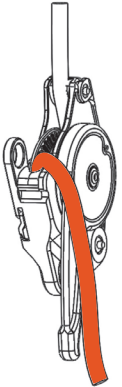
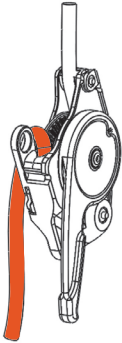

**WARNING:** When lowering, the tail of the rope should pass over the Friction Shoe, located adjacent to the Becket. Avoid placing the tail over the Sideplate or over the back of the Chassis.

10 | Precautions for Use

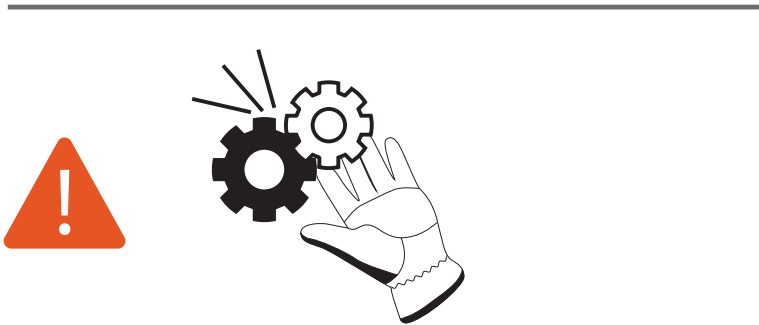
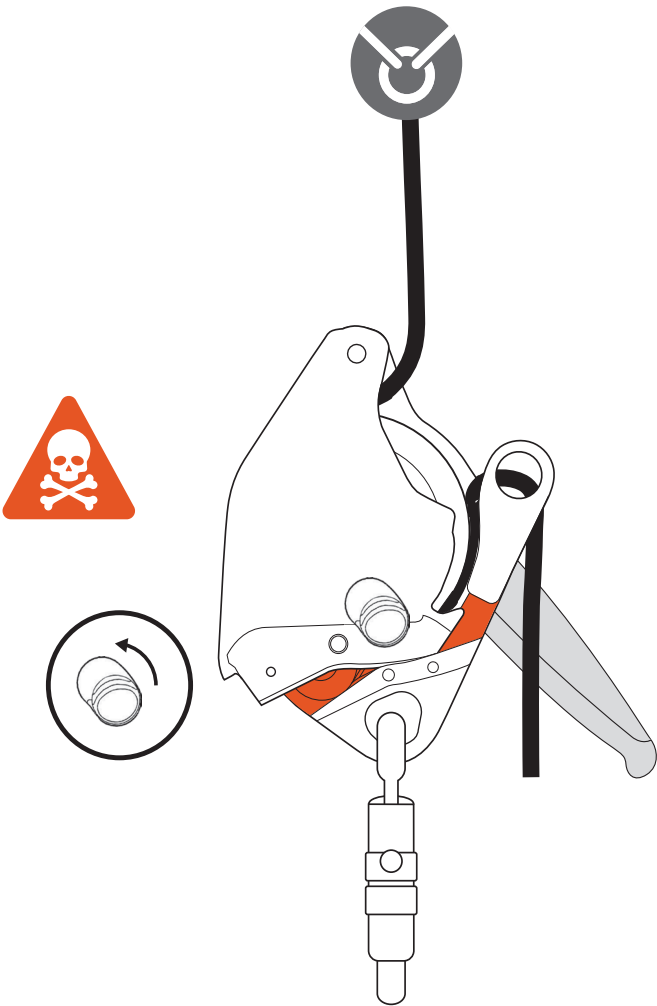
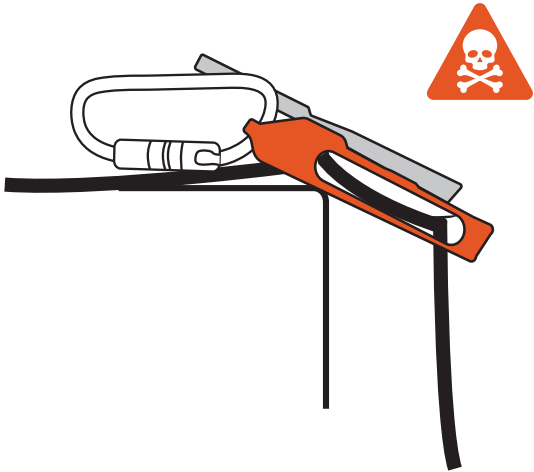
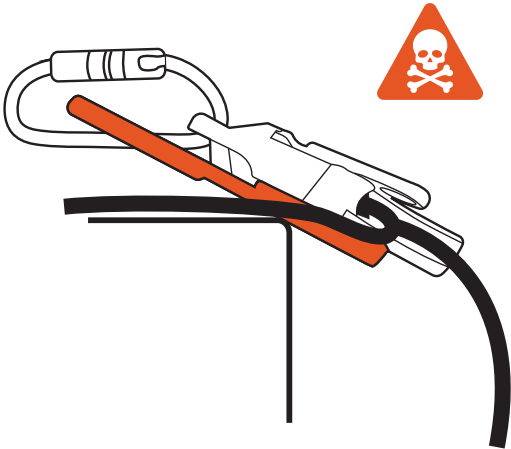

1



**DESCENT SPEED**

30-200 kg = 2 m/s MAX

200-240 kg = 0.5 m/s MAX



2

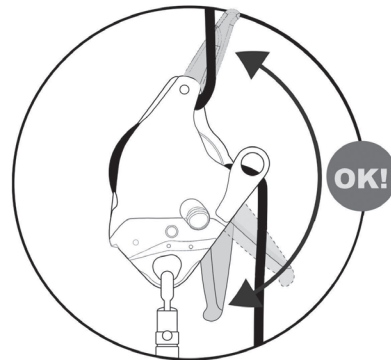
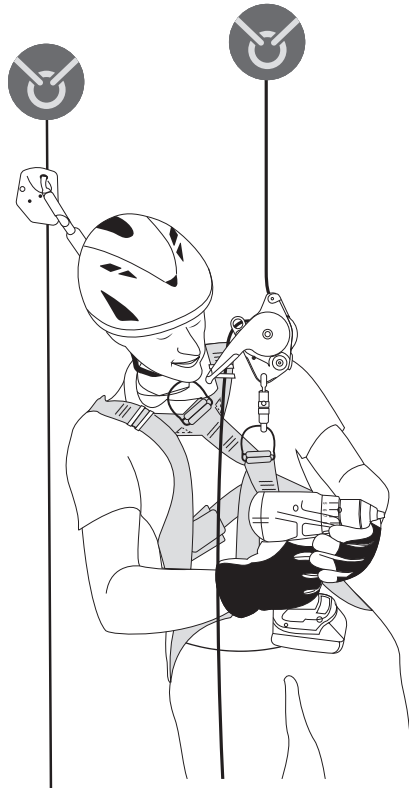

### **EN 12841:2006/C Descending**

The CLUTCH is an EN 12841 Type C rope adjuster used to descend the working line. The CLUTCH is a braking device for rope that allows the user to manually control the speed of descent and to stop anywhere on the rope by releasing the Control Handle. Use the same technique for sloping or horizontal terrain. To meet the requirements of the EN 12841:2006 Type C standard, use 10.5 - 11 mm EN 1891 Type A semi-static ropes (core + sheath). [Note: certification testing was performed using Teufelberger Patron 10.5 and 11 mm ropes.]

#### **1) Descent:**

Control your descent by varying the position of the Control Handle. Always grip the braking side of the rope. Release the Control Handle to stop the descent. In a panic situation: if the Control Handle is pulled too far the device brakes, then locks the rope. To continue the descent, first reset the Control Handle to the Stand By Position.

The maximum allowable speed is a function of the load on the device. For loads between 30 kg and 200 kg, limit the speed to below 2 m/s. For loads between 200 kg and 240 kg, limit the speed to below 0.5 m/s. The user should be competent at evaluating speed before descending. Speed can be judged by monitoring the flecking pattern on the rope passing through the device or by calculating target descent times for known distances. For heavy load and long descents, it is advisable to limit the speed to a lower value to minimize heat build up in the device.

**2) Work Positioning - Secured Stop:** After stopping at the desired location, to switch to the hands-free work positioning mode, lock the device on the rope by moving the handle to the Standby or Stop Position. To unlock the device and continue descent, firmly grip the braking side of the rope and gradually move the Control Handle to the Release Position.



**ATTENTION:** The primary function of a Type C rope adjustment device is progression along the working line. EN 12841 rope adjusters must not be used in fall arrest systems. The connection shall have a maximum length of 110 mm. An anchor rope loaded with the full weight of a user is a working line. A Type A back-up device connected to a safety line must be used. Ensure that the back-up system is never loaded onto the working line. Any overloading or dynamic loading may damage the anchor rope.

Attach the descender directly to your harness using an EN 362 locking carabiner. Never use lanyards or extensions of any type to connect the descender to your harness. Any equipment used with your descender must be in compliance with current standards.

Anchor lines should be attached to anchor points above the user, and any slack in the anchor line between the user and the anchors should be avoided.

The device was not tested to EN 12841/C 5.3.6, conditioning to oil or 5.3.7, conditioning to dust. Use caution when operating in conditions where oil and dust are present.

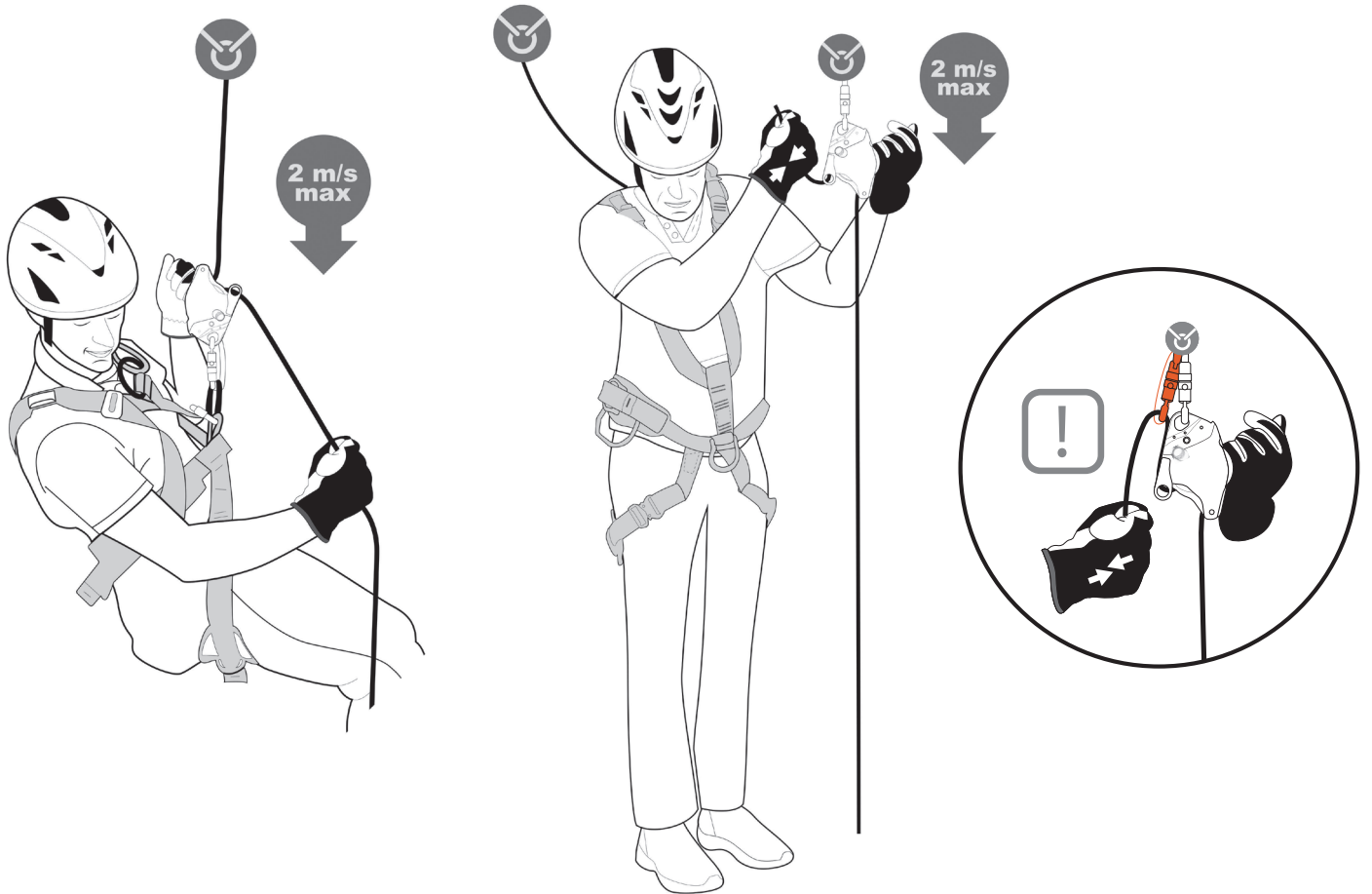

### EN 341:2011/2A Standard Information

#### WARNING: FOR RESCUE USE ONLY.

- The descender device should only be used by a person competent in its use following clear emergency protocols.
- Always maintain a firm grip on the braking side of the rope. Do not lose control during descent; loss of control may be difficult to recover.
- The connection of the descender device to the anchor point should be arranged so that the descent is not impeded.
- Any slack in the line between the user and the anchor point should be avoided.
- Always tie a stopper knot at the end of the line to create a bottom end stop.
- The device can overheat and damage the rope during descent.
- Always descend at a reasonable speed. (<2 m/s).
- Equipment left in place must be protected from the elements.

#### CLUTCH certification data with Teufelberger Patron 10.5 mm rope and Teufelberger Patron 11 mm rope:

- Descent weight m: 30-230 kg Ø 10.5 mm rope
- Descent weight m: 30-240 kg Ø 11 mm rope
- Descent height h: 200 m MAX
- Descent velocity V: 2 m/s MAX
- Operating temperature T: -30/+60°C
- Number of descents at 30 kg and 200 m: n = 127 MAX
- Number of descents at 240 kg and 200 m: n = 16 MAX
- **W = 9.81 x m x h x n**

**Lowering/Descent:** Firmly grip the braking side of the rope and gradually pull on the control handle to adjust the descent speed. To stop the descent let go of the control handle.

#### **Usage on Anchor**

In tight clearance or overhead rigging situations, an extra carabiner is recommended to improve ergonomics, redirect the rope and/or improve alignment of rope into the device. An extra carabiner may also be used to increase friction on the free end of the rope for heavy load applications.

**Maximum descent energy  
7.5 MJ**

Rope	Working load limit (EN341)	Maximum Descent
Teufelberger Patron 10.5 mm	230kg	200m
Teufelberger Patron 11 mm	240kg	200m

**Rope Specifications**

	Teufelberger Patron 10.5mm	Teufelberger Patron 11mm
1. Sheath Slippage (%)	0.5	0.2
2. Elongation (%)	3	3
3. Mass of the Sheath (%)	46	35
4. Mass of the Core Material (%)	54	65
5. Mass per Unit Length (g/m)	72	75
6. Shrinkage (%)	4	4
7. Material	Nylon	Nylon

### **ANSI Z359.4-2013 Standard Information**

Maximum descent height: 200 m.

Number of descents: 2.

Capacity load: 132 – 310 lbs. (60-141 kg).

Multiple use device.

Use static kernmantle ropes Ø 11 mm.

The Instructions for Use must be provided to the rescuer using this equipment. The Instructions for Use for each item of equipment used in conjunction with this product must be followed. Product inspection must be carried out according to the manufacturer's instructions for use and the product inspection form.

Anchors used must be strong enough to hold a static load of at least 13.8 kN or 5 times the load placed on the system. In a rescue, the anchors used for fall arrest must meet ANSI Z359.1 requirements. Connections to anchors must be done in a way that avoids any accidental movement of the system during rescue.

Connection of the device to an anchor or the user shall be accomplished by use of an ANSI Z359.12 carabiner. Connection of the rope to the individual or an anchor shall be via a figure eight follow through knot. Perform a tension test on the connection before applying the full load. In a rescue context, refer to ANSI Z359.4 and Z359. Rescue plan: you must have a rescue plan and the means to rapidly implement it in case of difficulties encountered while using this equipment.

**Warning: when using multiple items of equipment, make sure they are compatible. A dangerous situation can arise in which the safety function of an item of equipment can be affected by the safety function of another item of equipment. Be vigilant when working near sources of electricity, moving machinery, abrasive or sharp surfaces, or in an environment presenting chemical or extreme temperature hazards. The energy of descent is equal to the product of the descent length, the mass of the load, the acceleration of gravity, and the number of successive descents. Any misuse of this equipment will introduce additional dangers.**

**Lowering/Descent:** Firmly grip the braking side of the rope and gradually pull on the Control Handle to adjust the descent speed. To stop the descent let go of the Control Handle.

## 14 | Heavy Loads / Expert Use Only

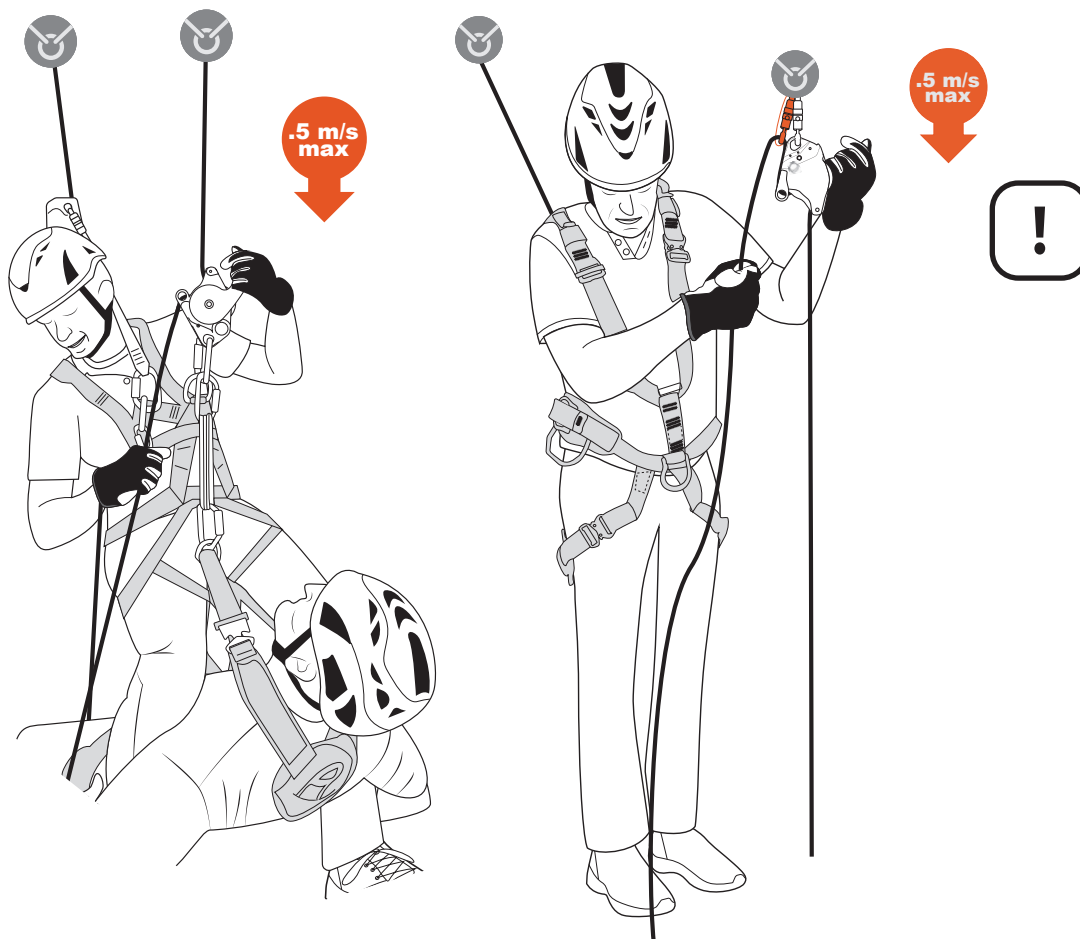

### Heavy Loads/Expert Use Only

For expert users specifically trained in this use, the CLUTCH can be used for loads up to 272 kg. These operations must only be performed by rescuers specifically trained in these uses. For heavy loads, shock-loading must absolutely be avoided. In these cases, users should take caution and always maintain a firm grip on the braking side of the rope.

### Heavy Loads, Expert Use Only - Descent/Lower

The CLUTCH can be used to descend and lower loads up to 272 kg. When lowering heavy loads maintain a speed of less than 0.5 m/s. An extra carabiner may also be used to increase friction on the free end of the rope. When lowering heavy loads from an overhead anchor it is recommended to use a secondary friction carabiner.

### Heavy Loads, Expert Use Only - Belaying

The CLUTCH can be used to belay loads up to 272 kg. When belaying heavy loads it is recommended to minimize slack in the system.



### **WARNING**

- SERIOUS INJURY OR DEATH MAY RESULT FROM THE IMPROPER USE OF THIS EQUIPMENT.
- THIS EQUIPMENT HAS BEEN DESIGNED AND MANUFACTURED FOR USE BY EXPERIENCED PROFESSIONALS ONLY.
- DO NOT ATTEMPT TO USE THIS EQUIPMENT WITHOUT PRIOR TRAINING.
- THOROUGHLY READ AND UNDERSTAND ALL LABELS AND INSTRUCTIONS BEFORE USE.
- USE, INSPECT AND REPAIR ONLY IN ACCORDANCE WITH MANUFACTURER'S INSTRUCTIONS.
- DO NOT ALTER OR MODIFY THE EQUIPMENT IN ANY WAY.

### **USER INFORMATION**

User Information shall be provided to the user of the product. NFPA Standard 1983 recommends separating the User Information from the equipment and retaining the information in a permanent record. The standard also recommends making a copy of the User Information to keep with the equipment and that the information should be referred to before and after each use. Additional information regarding life safety equipment can be found in NFPA 1500, *Standard on Fire Department Occupational Safety and Health Programs*, and NFPA 1983, *Standard on Life Safety Rope and Equipment for Emergency Services*.

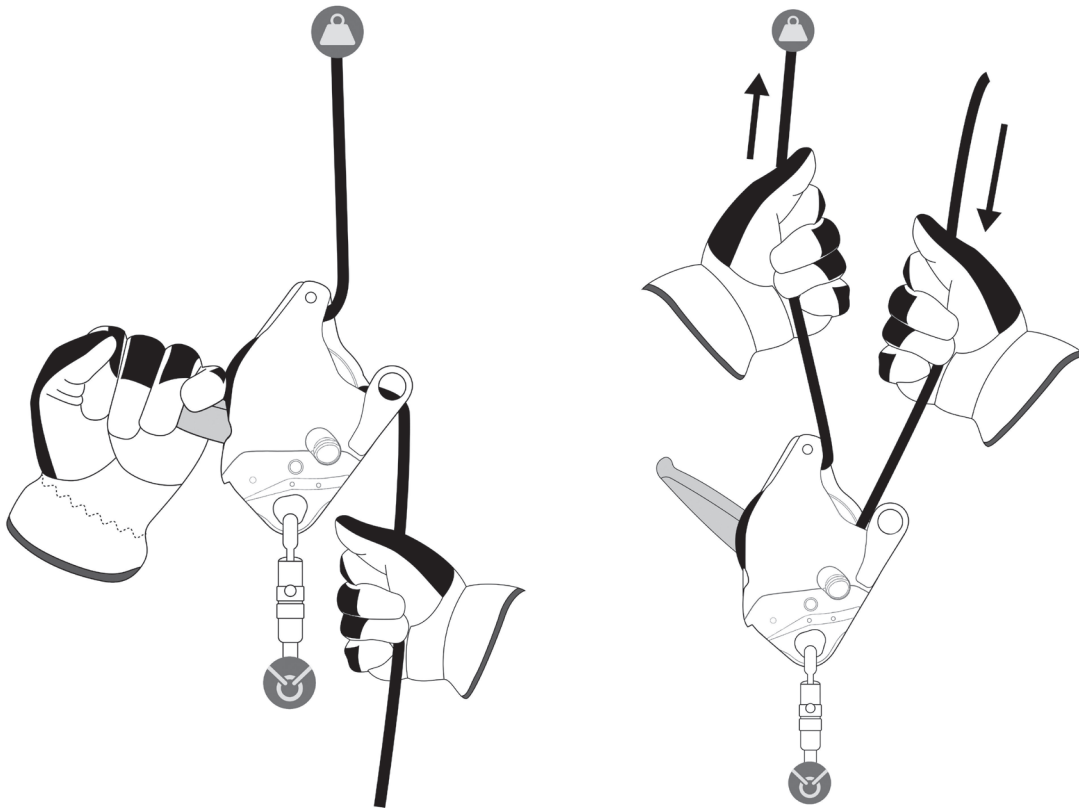

**Tensioned belay of a lowering system:** firmly grip the braking side of the rope and bring it back toward the anchor, parallel to the load end. Use the Control Handle to match the speed of the main line. **If there is a sudden change in speed or tension on the rope running through the CLUTCH, the belayer must immediately let go of the Control Handle (disengage) while maintaining a firm grip on the braking side of the rope to ensure the braking mechanism activates and arrests the load in the shortest distance possible.**

**WARNING: YOU MUST LET GO OF THE CONTROL HANDLE WHILE MAINTAINING A FIRM GRIP ON THE BRAKING SIDE OF THE ROPE TO ACTIVATE THE BELAY!**

**Slack belay:** To facilitate feeding the rope, focus more on pushing the rope into the device rather than pulling it out.

**To belay a raising system:** Simply pull the rope hand over hand through the device, keeping a firm grip on the braking side at all times.

The CLUTCH has been third party tested and certified to meet the impact force and system extension requirements of NFPA 1983 (2017 ED) belay device (auxiliary equipment) and dynamic tests of EN 341:2011/2A, EN 12841:2006/C & EN 15151-1:2012 Type 8.





Add an appropriate rope grab and traveling pulley to the working rope, and if desired a second change of direction pulley to the Becket of the CLUTCH, to build simple or compound mechanical advantage systems.

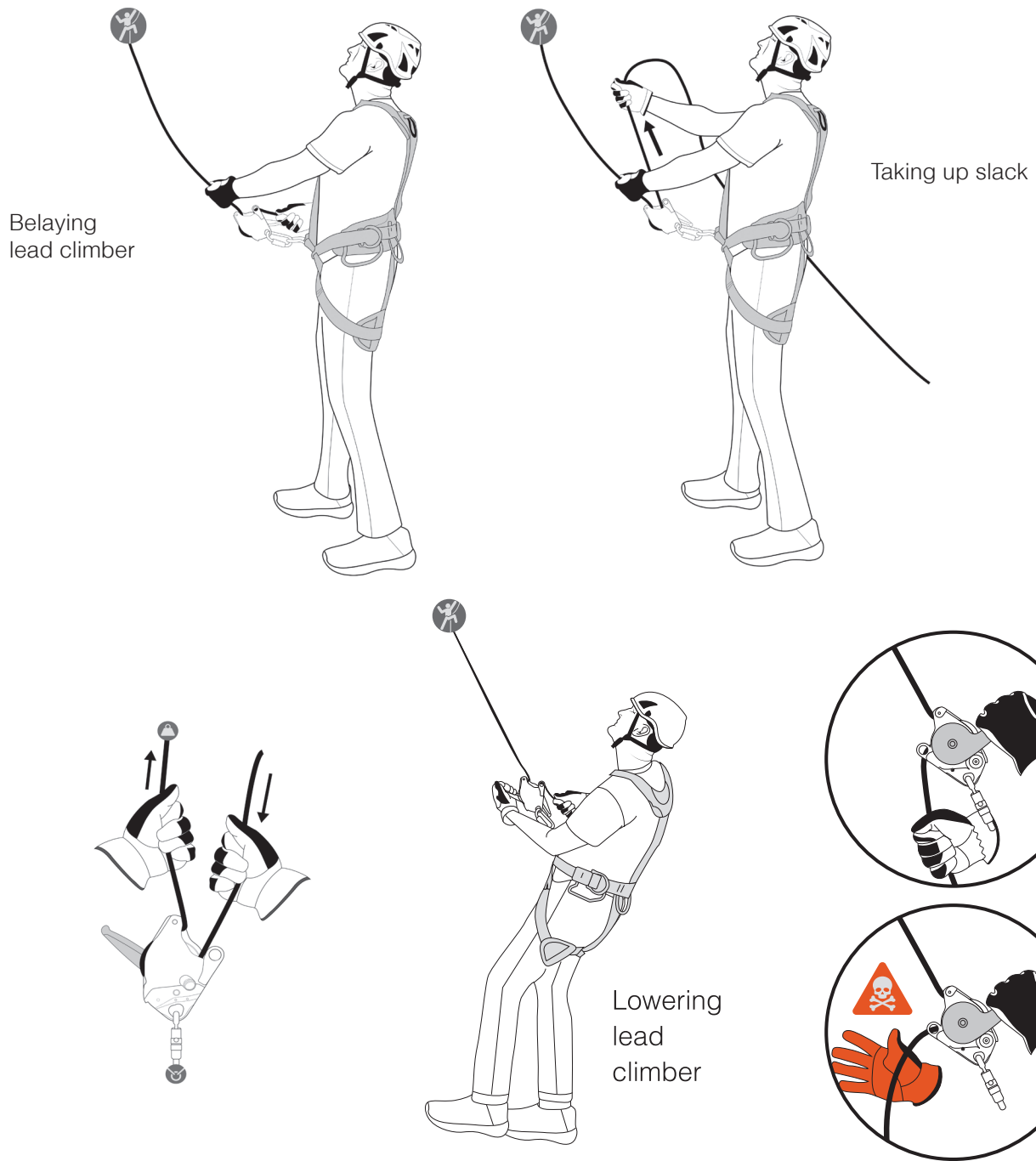

**Belaying Lead Climber**

EN 15151-1: 2012 type 8

Belay device with variable friction function for belaying in climbing and similar activities. Use only ropes in the diameter range indicated as compatible. Specified rope diameters have a tolerance of up to 0.2 mm. The diameter of a rope and its characteristics can vary depending on usage. Certification tests are carried out with an 80 kg mass. Keep minimum slack in the system. Never let go of the tail.

### **EN 15151-1:2012/8 Lead Climbing Belaying and Abseiling with a panic locking element**

EN 15151-1 compliant use of the CLUTCH is intended for mountaineering, climbing and related activities.

**WARNING: THE BRAKING EFFECT WILL BE DEPENDENT ON THE ROPE DIAMETER, SLICKNESS OF THE ROPE, WHETHER THE ROPE IS WET, AND OTHER FACTORS. CONDITIONS OF HIGH HUMIDITY, WET AND ICY CONDITIONS MAY ALSO AFFECT THE PERFORMANCE OF THE ROPE.**

#### **Belaying**

**WARNING: DANGER OF DEATH. ALWAYS MAINTAIN A FIRM GRIP ON THE BRAKING SIDE OF THE ROPE.**

Use only a dynamic single rope per EN 892 Ø 10.5-11mm.

Take particular care during the first meters of climbing; there is a danger that the minimum clearance distance under the user may not be sufficient. Avoid any slack in the rope. Anchoring may be below the user and able to sustain falls only in the case of climbing progression during EN 15151-1 use of the device with dynamic ropes. Connection to the anchoring point must be arranged in such a way so as not to impede descent.

Hold the braking side of the rope in one hand and the climber side in the other. To facilitate ease of rope feed through the device, focus more on pushing the braking side into the device than pulling the climber side out. To stop a fall, firmly grip the braking side of the rope.

#### **Abseiling**

Use only a dynamic single rope per EN 892 Ø 10.5-11 mm or semi-static rope per EN 1891/A Ø 10.5-11 mm. Take up all slack, then firmly grip the braking side of the rope. Lower the lead climber, using the Control Handle to manage the rate of descent.

19 | Ascending

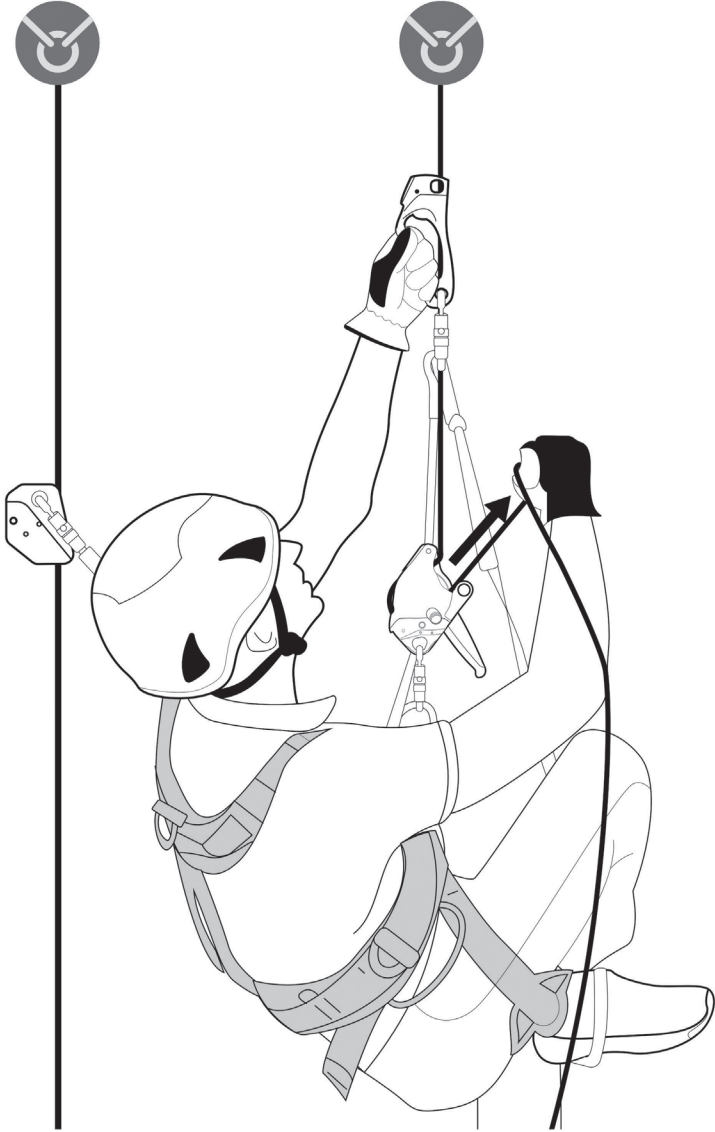

Attach the CLUTCH to the harness with the Control Handle in the Stand By position. For greater efficiency, take up slack as you stand up using the Rope Grab. Never allow slack between the Rope Grab and the CLUTCH.

## 20 | Additional Information



### Nomenclature of Symbols

1. Audible / Sound
2. Load
3. Anchor / Harness Connection
4. Lead Climber
5. Imminent Risk of Injury or Death
6. Important information on the functioning or performance of your product
7. Maximum Velocity
8. Visual Check
9. Imminent Risk of Accident or Injury
10. Anti-panic

## 21 | Equipment Record

<b>Product Name, Model</b>	CLUTCH, CMC P/N 335011
<b>Product Type</b>	Rescue Descender / Working Line Descender / Braking device with manually assisted locking / Pulley
<b>Patent No.</b>	US20160296771A1
<b>Manufacturer</b>	CMC RESCUE, INC 6740 Cortona Drive Goleta, CA 93117 USA
<b>Tel, Fax, Email and Website</b>	Tel: 800-235-5741 / 805-562-9120 Fax: 800-235-8951 / 805-562-9870 Email: info@cmcpro.com Web: www.cmcpro.com
<b>User</b> (company, name, and address)	
<b>Individual Product Number</b>	
<b>Year of Manufacture</b>	
<b>Purchase Date</b>	
<b>Date of First Use</b>	
<b>Expiration Date</b>	
<b>Notified Body that Performed the EU Type Examination</b>	DOLOMITICERT SCARL 7/A Via Villanove, Longarone BL 32013, Italy Tel. +39.0437.573407 Fax +39.0437.573131

## 22 | Device Periodic Check Sheet

No.	Date	Reason for Check	Notes (damage, defects, excessive wear or other relevant data)	Check Results	Name & Signature of Competent Person Performing Check	Date of Next Check
1		<input type="radio"/> Periodic check <input type="radio"/> Additional check		<input type="radio"/> Device suitable for use <input type="radio"/> Device NOT suitable for use <input type="radio"/> Secondary check required		
2		<input type="radio"/> Periodic check <input type="radio"/> Additional check		<input type="radio"/> Device suitable for use <input type="radio"/> Device NOT suitable for use <input type="radio"/> Secondary check required		
3		<input type="radio"/> Periodic check <input type="radio"/> Additional check		<input type="radio"/> Device suitable for use <input type="radio"/> Device NOT suitable for use <input type="radio"/> Secondary check required		
4		<input type="radio"/> Periodic check <input type="radio"/> Additional check		<input type="radio"/> Device suitable for use <input type="radio"/> Device NOT suitable for use <input type="radio"/> Secondary check required		
5		<input type="radio"/> Periodic check <input type="radio"/> Additional check		<input type="radio"/> Device suitable for use <input type="radio"/> Device NOT suitable for use <input type="radio"/> Secondary check required		
6		<input type="radio"/> Periodic check <input type="radio"/> Additional check		<input type="radio"/> Device suitable for use <input type="radio"/> Device NOT suitable for use <input type="radio"/> Secondary check required		
7		<input type="radio"/> Periodic check <input type="radio"/> Additional check		<input type="radio"/> Device suitable for use <input type="radio"/> Device NOT suitable for use <input type="radio"/> Secondary check required		

**IMPORTANT:**

A periodic inspection shall be performed at least once every 12 months and again after any exceptional event(s) that may occur during use of the product to ensure product safety for users. The inspection shall be performed by a competent person. Additional information on the inspection process and an inspection checklist can be found at [www.cmcpro.com/ppe-inspection](http://www.cmcpro.com/ppe-inspection).



**CMC Rescue, Inc.**  
**6740 Cortona Drive**  
**Goleta, CA 93117, USA**  
**805-562-9120 / 800-235-5741**  
**cmcpro.com**

ISO 9001 Certified  
©2019 CMC Rescue, Inc. All rights reserved  
CMC and  are registered marks of CMC Rescue Inc.  
Control No. MAN-335011.03.101019